

连接板

2D·3D CAD DATA

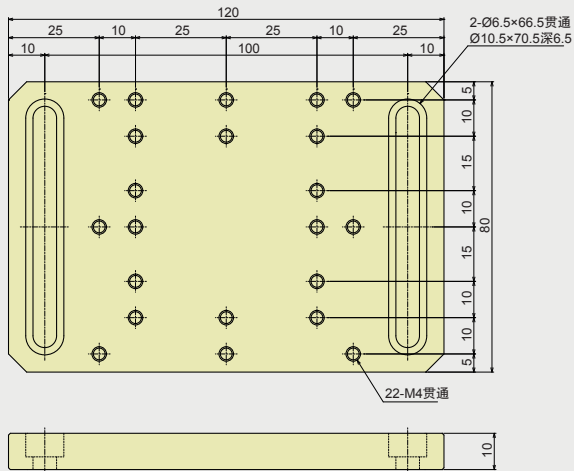

B128



B160

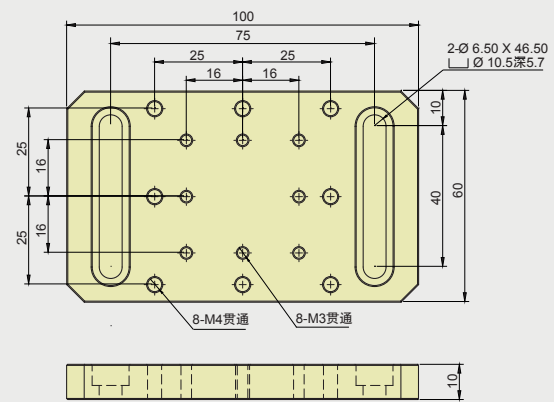

B64

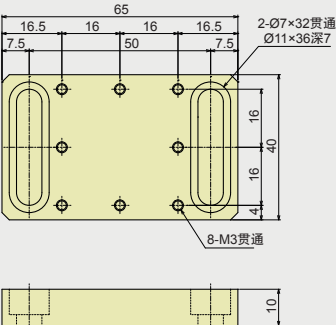

B6076-5

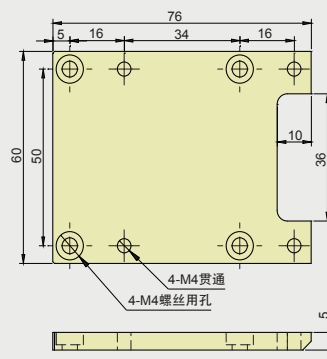

B24-10

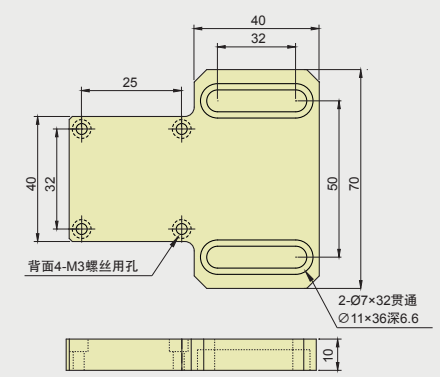

手动
位移台
/单轴

多轴/
组合
单元

电动
位移台
/单轴

X

Z

水平Z轴

高分辨率

旋转

倾斜

弧摆

连接板

X Y

X Y Z

水平Z轴
X Y Z

X Y θ

X Y Z θ

组合单元

交叉滚
柱导轨

直线滚
珠导轨

燕尾式
导轨

配件

应用
系统

连接板

B4040-A8(10)

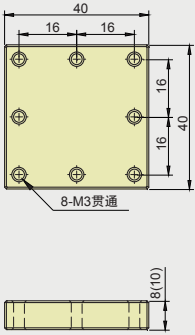

B4040-B8(10)

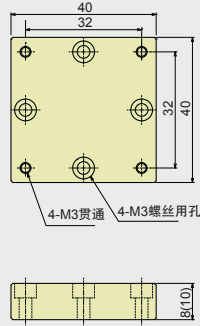

B4040-C8(10)

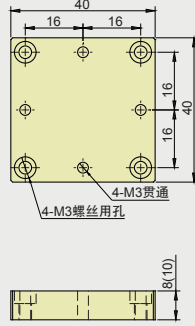

B4040-D8(10)

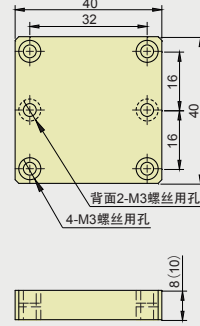

B4040-E8(10)

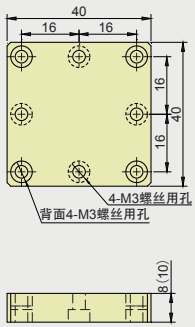

B50

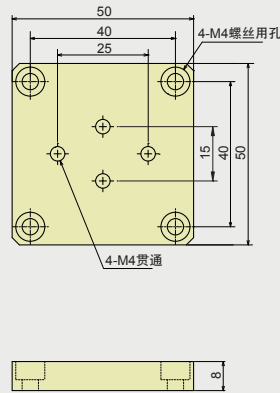

B6060-A10

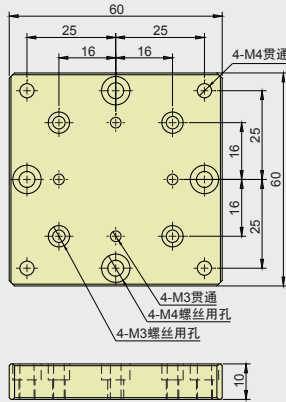

B6060-B8

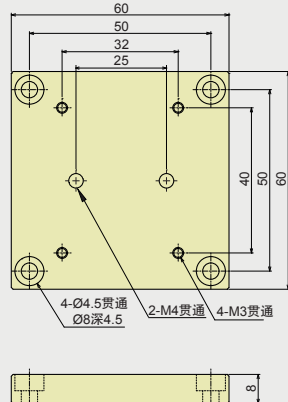

B80-10

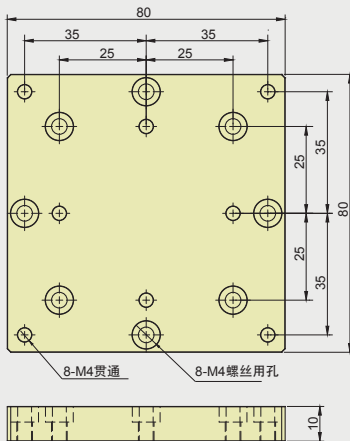

手动
位移台
/单轴

多轴/
组合
单元

电动
位移台
/单轴

X

Z

水平Z轴

高分辨率

旋转

倾斜

弧摆

连接板

X Y

X Y Z

水平Z轴
X Y Z

X Y θ

X Y Z θ

组合单元

交叉滚
柱导轨

直线滚
珠导轨

燕尾式
导轨

配件

应用
系统